

# WATT'S NEW



# TABLE OF CONTENTS



**KLEIN  
TOOLS**

PLIERS.....	1-2
STRIPPERS, CUTTERS & CRIMPERS.....	3
SCREWDRIVERS & NUT DRIVERS.....	4-8
KNIVES & CUTTING TOOLS.....	9-10
MEASURING TOOLS.....	11
LEVELS & HEX KEYS.....	12
WRENCHES.....	13
WIRE PULLING & CONDUIT TOOLS.....	14
PPE & SAFETY PRODUCTS.....	15-17
JOBSITE ACCESSORIES.....	18
TOOL BAGS & STORAGE.....	19-22
TOOL POUCHES & ACCESSORIES.....	23-26
ILLUMINATION.....	27
HOLEMAKING PRODUCTS & ACCESSORIES.....	28
TEST & MEASUREMENT.....	29-34
VOICE/DATA/VIDEO.....	35-38



ROOFING TOOL.....	39
-------------------	----



ENCLOSURES & GLANDS.....	40-41
FIXINGS & FASTENINGS.....	42-43
LUGS & LINKS.....	44-45



CRIMPING.....	46-47
HAND TOOLS.....	48
TOOL KITS & CABLE PULLING.....	49
GENERAL EVERYDAY NEEDS.....	50-51



# TRADES CLUB

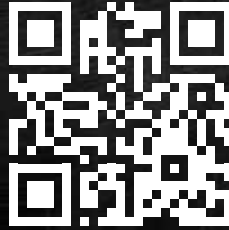

News, Products, & Prizes

**JOIN NOW**

## Insulated Lineman's Pliers, 9-Inch

- Individually tested to exceed the IEC 60900 and ASTM F1505 standards, for insulated tools, and clearly marked with the official 1000-volt rating symbol
- Two layers of insulation provide protection against electric shock
- Thick, exceptionally tough, high-dielectric white inner coating is bonded to the tool
- A flame retardant, impact-resistant, bright orange outer coating
- High-leverage design provides 46-Percent greater cutting and gripping power than other plier designs
- Cuts ACSR, screws, nails, and most hardened wire
- Integral guards help prevent hand contact with conductive parts



A-D2000-9NE-EINS

## Diagonal Cutting Pliers, Insulated, High Leverage, 8-Inch

- Klein Tools Pliers are individually tested to exceed the IEC 60900 and ASTM F1505 standards, for insulated tools, and clearly marked with the official 1000-volt rating symbol
- Two layers of insulation provide protection against electric shock
- Thick, exceptionally tough, high-dielectric white inner coating is bonded to the tool
- A flame retardant, impact-resistant, bright orange outer coating
- High-leverage design. Rivet is closer to the cutting edge for 36-percent greater cutting power than other plier designs
- Integral guards help prevent hand contact with conductive parts
- Made of forged steel for maximum durability



A-D228-8-INS

### Diagonal Cutting Pliers, Electronics, Pointed Nose, Narrow Jaw, 5-Inch

- Diagonal Cutters with narrow jaw and hinge for delicate work in tight areas
- Pliers have sharp pointed nose and flush cutting blades for precise tip cutting
- Spring-loaded action for self-opening
- Short jaws and beveled cutting edges permit close cutting of wire
- Induction-hardened cutting knives for long life
- Hot-riveted joint ensures smooth action and no handle wobble
- Plastic-dipped handles for comfort and ease of identification
- Custom, US-made tool steel



A-D244-5C

### Diagonal Cutting Pliers, Heavy-Duty, All-Purpose, 6-Inch

- Diagonal Cutting Pliers with short jaws and beveled cutting edges permit close cutting of wire
- Tapered nose for easy working in confined areas
- Heavier design for all-purpose use
- Induction-hardened cutting knives for long life
- Hot-riveted joint ensures smooth action and no handle wobble
- Plastic-dipped handles for comfort and ease of identification
- Custom, US-made tool steel



A-D252-6

### Pliers, Long Nose Side-Cutters, 6-3/4-Inch

- Induction-hardened cutting knives for long life
- Knurled jaws for sure wrapping and looping
- Slim head design for working in confined areas
- Hot-riveted joint ensures smooth action and no handle wobble
- Curved handles provide greater tool control
- State-of-the-art, dual material Journeyman™ handles provide a better grip without sacrificing tool strength or durability
- Hard, black material for toughness and durability
- Soft material on outer surface for comfort and a firm grip
- Color-coded handles allow quick identification of tool
- Custom, US-made tool steel



A-J203-6



## Klein-Kurve® Heavy-Duty Wire Stripper / Cutter / Crimper Multi Tool, 8-20 AWG

- Wire Stripper with six stripping holes for 8-18 AWG solid and 10-20 AWG stranded wire
- Multi Tool's side cut design features longer knives for more cutting
- Crimps non-insulated connectors, lugs and terminals for 10-20 AWG stranded wire
- Knurled jaw for twisting, grabbing and looping wire
- Twists up to three wires at a time
- High leverage design for improved performance
- Klein-Kurve® comfort grip handles for reduced hand fatigue
- Induction hardened cutting knives for long life
- Hot-riveted joint ensures smooth action and no handle wobble



A-K12065CR

## Klein-Kurve Long-Nose Wire Stripper, Wire Cutter, Crimping Tool

- Wire Stripper strips 10-20 AWG solid, 12-22 AWG stranded wire
- Multi Tool crimps insulated and non-insulated connectors
- Tip designed to grab, pull and bend the smallest of wires
- Reinforced head reduces flex
- Optimized for ideal leverage when stripping and crimping
- Precision shear-type cutting blades for easier cutting
- Do not use to cut steel wire
- Patent US D827,403



A-1009

Klein Tools Cable Cutters have been specifically designed to cut and strip aluminium and copper cable with ease. Our team of engineers developed these new Cable Cutters to give professionals a durable forged tool steel option for durability and longevity. The two blade profiles maximise the efficiency of cutting and stripping.

**Two blade profiles** maximize the efficiency of cutting and stripping

**Precision hardened** and sharpened shear cutters for clean, round cuts

**Riveted joint** ensures smooth maintenance-free action

**Forged tool steel** for durability

**Plastic dipped** handles for comfort

**High leverage design** cuts & strips up to 9 mm aluminium and copper cable with ease\*



**63213**  
**CUTS & STRIPS**  
Up to 9mm 50mm<sup>2</sup>  
COPPER/ALUMINIUM



**63217**  
**CUTS & STRIPS**  
Up to 11mm 70mm<sup>2</sup>  
COPPER/ALUMINIUM



Do NOT use to cut steel or ACSR

Cat. No.	Barcode	Cutting Capacity	Overall Length	Weight
63213	092644632136	Up to 9mm Aluminium & Copper	160mm (6.3")	170g
63217	092644632174	Up to 11mm Aluminium & Copper	210mm (8.25")	300g

## 8-in-1 Insulated Interchangeable Screwdriver Set

- Interchangeable Insulated Screwdriver Set with an insulated handle, 5 interchangeable insulated blades, and a carrying pouch
- Screwdriver Set includes tip sizes: two #2 Phillips, two 1/4-Inch Slotted, one #1 Phillips, one #1 Square, one #2 Square, and one 3/16-Inch Slotted
- Securely and easily release the blade with a quick twist of the lock collar
- Interchangeable blades with a slim-tip to fit tight terminal blocks
- Handle and blade have a 1000-Volt insulation rating and meets or exceeds ASTM F1505 standard for insulation
- A layer of orange impact and flame resistant insulation protects from electric shock
- Cushion-Grip handles for greater torque and comfort
- Double-ended blades have a 3.5-Inch shaft length, single-ended blades have 5.75-Inch shaft length
- Durable, carrying roll pouch keeps the set organized and protected



A-32288

## 15-in-1 Multi-Bit Ratcheting Screwdriver

- Multi-Bit screwdriver features a durable ratcheting mechanism for faster and easier all-day driving
- On-board storage of 14 different double-sided screwdriver bits and a 1/4-Inch nut driver
- Industrial-strength bits that are conveniently housed in the handle
- Collar sets ratchet direction at forward, fixed and reverse
- Cushion-Grip handle for great torque and maximum comfort
- Spin cap for optimum and precise control
- Includes Phillips (#0, #1, #2, #3), Slotted (3/16-Inch, 1/4-Inch), Square (#1, #2), Torx® (T10, T15, T20, T25), and Combo (#1, #2) bits
- TORX® is a registered trademark of Acument Intellectual Properties, LLC



A-32305

## HVAC Slide Drive™ Multi-Bit Screwdriver / Nut Driver, 8-in-1

- 8-in-1 Screwdriver / Nut Driver with unique, patented head that slides back and forth to switch from 1/4-Inch to 5/16-Inch magnetic hex-head screwdriver
- Thumb nut locks tip setting
- Features a specialty bit for installation/removal of common TR-4 Schrader® valves
- Includes 1/4-Inch and 3/8-Inch hollow nut drivers, as well as #2 Phillips, 1/8-Inch (3 mm) and 1/4-Inch (6 mm) slotted screwdriver tips
- Cushion-Grip handle for greater torque and comfort
- Great for HVAC applications including thermostat installation and control work
- U.S. patent 7,654,175 B2



A-32596



## 7-in-1 Nut Driver

- Strong, rare earth magnets securely hold nuts and bolts (7mm, 8mm, 9mm, 10mm, 12mm)
- Spring coil holds nuts and bolts in place without the use of magnets (11mm, 13mm)
- Hollow shafts for driving nuts deep onto bolts or threaded rod (7mm, 8mm, 9mm, 10mm, 12mm)
- Heavy-duty handle and shaft exceed the torque performance of regular nut drivers
- Wrench-assist on handle for added torque on tough jobs
- Color-coded bands for easy identification

EASY,  
ONE-HANDED  
DRIVING WITH  
SEVEN SIZES  
IN ONE TOOL!

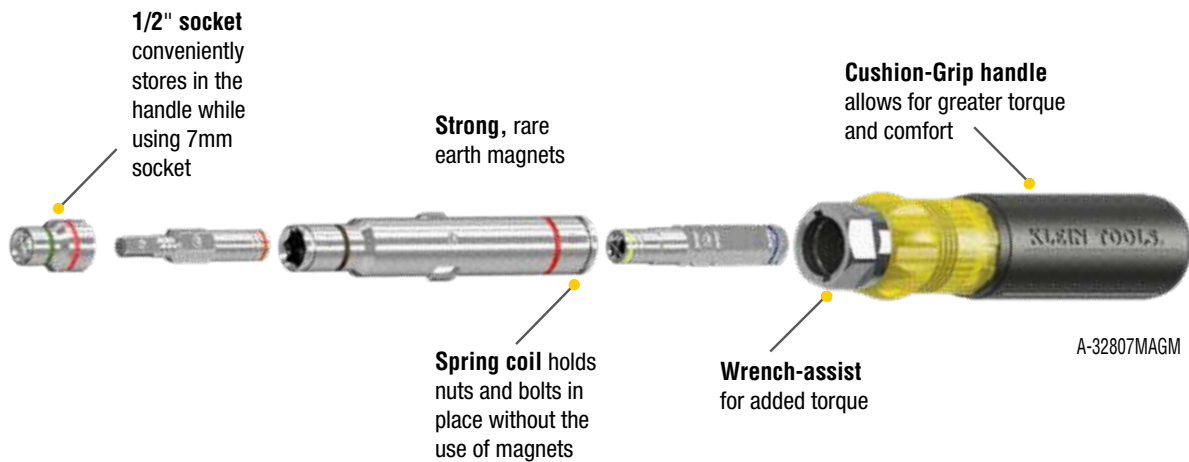

## All-in-1 Precision Screwdriver Set with Case

- Precision screwdriver set includes 39 bits for various applications including repair of most Apple® products
- Powerful magnets inside barrel to better retain bits, as well as pick-up and hold fasteners
- Reversible barrel has standard and extended-reach ends
- Compact carrying case features a stay-shut latch and extra-long bits for easier access
- Spin cap offers optimum and precise control
- Industrial-strength heat treated bits
- Cushion-Grip handles for maximum comfort
- Apple® is registered trademarks of Apple Inc; TORX® is a registered trademark of Acument Intellectual Properties, LLC; Tri-Wing® is a registered trademark of Phillips Screw Company



## Nut Driver Set, 1000V Insulated, 9-piece

- Tool set includes 3/16-Inch, 1/4-Inch, 5/16-Inch, 11/32-Inch, 3/8-Inch, 7/16-Inch, 1/2-Inch, 9/16-Inch and 5/8-Inch nut drivers
- Nut Drivers with Full hollow shafts facilitate work on long bolt applications
- Durable, two-layer, molded insulation protects against electric shock
- Tip-Ident® quickly identifies nut driver and size
- Highly durable, black, nylon case features custom-fitted tool pockets
- Replacement case available (Cat. No. 33534)
- Meets or exceeds IEC 60900: 2012, ASTM F1505-10 standards for insulated tools



## Screwdriver Set, 1000V Insulated Slotted and Phillips, 9-Piece

- Screwdriver Set features three sizes of cabinet, keystone and Phillips tips. (See individual tool listings for more details)
- Insulated screwdrivers have two layers of insulation to provide protection against electric shock
- Meets or exceeds IEC 60900: 2012, ASTM F1505-10 standards for insulated tools
- Highly durable, black nylon case features zipper closure, custom-fitted pockets and an extra pocket for additional storage
- Replacement case available (Cat. No. 33538)



A-33528

## Multi-Bit Electronics Screwdriver, 4-in-1, Phillips, Slotted Bits

- Electronics Screwdriver with four different non-magnetic tips in one tool, includes No. 0 and No. 00 Phillips plus 1/8" (3.2 mm) and 3/32" (2.4 mm) Slotted tips
- Rotating caps for optimum and precise control
- Corrosion-resistant chrome-plated barrel that includes two double-ended bits that exceed ANSI standards
- Cushion-Grip handles for maximum comfort when working on small equipment.
- Heat-treated, precision-ground tip for greater strength.
- Has interchangeable shaft for quick bit switch outs
- Lightweight, only 1.1 oz (31 g)



A-32581

## Slotted Screw Holding Screwdriver 6-Inch

- Start and drive 1/4-Inch slotted screws with one hand
- Split-blade screw-holding driver wedges into screw slot
- Positive gripping action holds, starts, and drives slotted screws in awkward, hard-to-reach places
- Not designed for torquing or tightening
- Blade thickness of .043-Inch (1 mm) expanding to .085-Inch (2 mm)



A-K36

Cat. No.	Tip Type	Shank Type	Overall Length	Weight
A-K36	6.4 mm Slotted	Round	248 mm	0.07 kg
A-K44	7.9 mm Slotted	Round	210 mm	0.11 kg
A-K46	7.9 mm Slotted	Round	260 mm	0.11 kg
A-K48	7.9 mm Slotted	Round	311 mm	0.14 kg



## Screwdriver Set, Slim-Tip Insulated Phillips, Cabinet, Square, 4-Piece

- Slim-Tip Insulated Screwdriver Set includes: 4-Inch round shank in a #2 Phillips and 1/4-Inch Cabinet tips; 6-Inch round shank in a #2 Square and 3/16-Inch Cabinet tips
- 1000-Volt rated insulated screwdrivers with slim-tips that allow for greater access into tight spaces
- Insulated blade is flush with the tip to help reduce nicking the insulation
- Layer of orange impact and flame-resistant insulation protects from energized sources
- Cushion-grip handles for greater torque and comfort
- Meets or exceeds ASTM F-1505-16 and IEC 60900:2018
- Made in the USA



A-33734INS

## Screwdriver Set, 1000V Insulated Slotted and Phillips, 2-Piece

- Screwdriver Set includes one 1/4-Inch Cabinet-Tip (Cat. No. 602-4-INS) and one #2 Phillips-Tip (Cat. No. 603-4-INS)
- Insulated screwdrivers reduce risk with work up to 1000 volts
- Durable, two-layer, molded insulation
- Orange outer coating is flame and impact resistant
- White high-dielectric inner coating is bonded to the steel
- Cushion-Grip handles for greater torque and comfort
- Meets or exceeds IEC 60900 and ASTM F1505 standards for insulation
- Made in the USA
- Includes non-magnetic tips



A-33532-INS

## Screwdriver Set, Slim-Tip Insulated Phillips and Cabinet Tips, 2-Piece

- Slim-Tip Insulated Screwdriver Set sizes: 4-Inch round shank in a #2 Phillips and a 1/4-Inch Cabinet tip
- 1000-Volt rated insulated screwdrivers with slim-tips that allow for greater access into tight spaces
- Layer of orange impact and flame-resistant insulation protects from energized sources
- Insulated blade is flush with the tip which helps reduce nicking the insulation
- Cushion-grip handles for greater torque and comfort
- Meets or exceeds ASTM F-1505-16 and IEC 60900:2018
- Made in the USA



A-33732INS

## Insulated Screwdriver, #1 Phillips Tip, 4-Inch

- 1000V Rated for safety
- Durable, two-layer, molded insulation to meet or exceed all ASTM and IEC standards for insulated tools
- Cushion-Grip handles for greater torque and comfort
- Custom US-made tool steel
- Made in the USA



A-6334INS

## Insulated Screwdriver, #3 Phillips, 7-Inch Shank

- 1000V Rated for safety
- Durable, two-layer, molded insulation to meet or exceed all ASTM and IEC standards for insulated tools
- Cushion-Grip handles for greater torque and comfort
- Custom US-made tool steel
- Made in the USA



A-6337INS

## Insulated Screwdriver, 3/16-Inch Cabinet, 4-Inch

- 1000V Rated for safety
- Durable, flame-retardant, molded dual-layer insulation
- Custom US-made tool steel
- Made in the USA



A-601-4-INS

## Insulated Screwdriver, 3/16-Inch Cabinet, 7-Inch

- 1000V Rated for safety
- Durable, two-layer, molded insulation to meet or exceed all ASTM and IEC standards for insulated tools
- Custom US-made tool steel
- Cushion-Grip handle for superior torque and comfort
- Made in the USA



A-601-7-INS

## Insulated #2 Phillips Screwdriver, 7-Inch

- 1000V Rated for safety
- Durable, two-layer, molded insulation to meet or exceed all ASTM and IEC standards for insulated tools
- Cushion-Grip handle for greater torque and comfort
- Custom US-made tool steel
- Made in the USA



A-6037INS

## Insulated 1/4-Inch Cabinet Tip Screwdriver, 7-Inch

- 1000V Rated for safety
- Durable, two-layer, molded insulation to meet or exceed all ASTM and IEC standards for insulated tools
- Custom US-made tool steel
- Cushion-Grip handle for superior torque and comfort
- Made in the USA



A-605-7-INS

## Electrician's Scissors, Nickel Plated

- Scissors are designed for telecom, electrical and heavy-duty use applications
- Electrician Snips cut 19 AWG and 23 AWG electrical communication wire, cable and cordage
- Upper blade has notches to strip 19 AWG and 23 AWG wire
- Strong, tempered steel
- Nickel-plated finish resists corrosion
- Scraper and file on outside of both blades
- Serrated teeth allow for non-slip cutting action



A-2100-7

---

## Free-Fall Snip Stainless Steel

- Free-fall snips with stainless steel blades to maintain blade durability and sharpness
- Blade is fully serrated for non-slip cutting action
- Free-fall snip feature for ease of use
- Cuts electrical communication 19 AWG and 23 AWG wire
- Extended handle provides comfort and cutting leverage for wire cutting applications



A-2100-8

---

## All-Purpose Electrician's Scissors

- Cable cutting notch in scissor blade provides increased leverage and stability on tough cuts of up to 14 AWG wire
- Electrician Scissors strip 19 and 23 AWG wire
- Durable, forged high carbon steel blades maintain sharpness and outlast stamped designs
- Ergonomic handle fits a variety of hold preferences
- Notch in tip for deburring electrical boxes
- Serrated teeth allow for non-slip cutting action
- Scraper on both blades for cleaning wire
- U.S. Patent pending



A-26001

**Stainless Steel Pocket Knife 3-Inch Steel Blade**

- Compact and lightweight knife
- Stainless steel handle and blade for long life
- Hardwood handle inserts on both sides
- Modified spearpoint blade locks open



A-44034

**Sportsman Knife Drop Point 3-3/8-Inch**

- Curved handle with big bolster
- Brass bolster and ebony wood handle
- Stainless steel blade and brass lining ensure long life
- 3-3/8-Inch (86 mm) blade length
- Blade locks open
- Comes with leather snap case with belt loop



A-44037

**Utility Blade Dispenser with 50 Blades**

- 50 blades included
- High quality, triple ground blades stay sharp longer
- Gauge on dispenser indicates blades remaining
- Convenient interim storage for used blades
- Blades are compatible with all standard utility knives



A-44103

**Cable Splicer's Knife, 6-1/2-Inch**

- Special-purpose short blade with comfortable, full-sized, heavy-duty handle
- Coping-type blade made of the finest cutlery steel, tough and carefully tempered to hold its edge
- Handle is textured for comfort and firm grip
- Hang hole for easy storage and portability



A-44200

**Cable Splicer's Kit**

- Includes cable splicer's knife, electricians scissors, and 2-pocket leather pouch
- Cuts cable, telephone wire, and strips insulation
- Dimensions: 2-1/8-Inch (54 mm) x 7-1/2-Inch (191 mm)
- Knife's textured handle provides comfortable grip
- Pouch is riveted and stitched for added durability
- Electrician's Scissors feature wire stripping notches



A-46037



## Tape Measure, 9-Meter Magnetic Double-Hook



**HEAVY-DUTY  
NYLON COATING**  
FOR LONGER BLADE LIFE &  
PROTECTS BLADE PRINTING

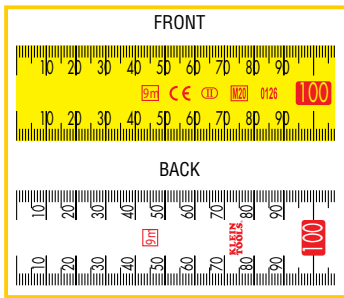

**MEASUREMENT SCALE**  
PRINTED ON FRONT AND  
BACK SIDES OF BLADE



● **Metal belt-clip**  
for secure hold



● **Uncluttered, easy to read**  
metric scales

**Retraction Brake** for speed  
control and finger protection

**Magnetic double hook** attaches  
easily to conduit and steel studs

**4 meter standout** of wide, tough and durable blade



Cat. No.	Barcode	Blade Length	Hook	Magnetic	Measurement Scale	Tape Print
A-86000	092644860003	9m	Double	Yes	Metric	Double-sided

## Tape Measure, 7.5-Meter Magnetic Double-Hook

- Tape Measure with 4-Meter standout of wide, tough and durable blade
- Uncluttered, easy-to-read metric and imperial (SAE) scales on front and back side of tape
- Heavy-duty, tough, durable nylon-coating protects blade printing and delivers longer blade life
- Retraction speed brake controls blade speed and protects fingers from touching blade
- Measurement scale printed on front and back sides of blade for versatility to address different types of measurements
- Double hook can secure tape to items such as studs, conduit, pipes, etc. on front or back side of blade to measure with either measurement scale
- Strong magnet on hook attaches to ferromagnetic objects such as steel studs, doors, panels, conduit, etc. for easy measuring
- The impact resistant housing is over-molded with a soft touch finish for excellent grip and stands up to jobsite demands
- Metal belt-clip securely holds tape measure to belts, pockets, or pouches
- Integrated tether hole for use at height
- US Patent D803711



**Torpedo Billet Level, Rare Earth Magnet**

- Level's patented magnet track prevents powerful rare earth magnets from falling out
- Large, easy-to-read high-visibility vials at 4 angles: level, 90, 45, and 30 degrees
- Large, top-view vial window enables easy readability from multiple angles
- High-visibility orange body is easy to see on conduit and at the jobsite
- V-Groove fits contour of conduit and pipe
- Tapered nose easily pushes into pockets
- US Patent 9,964,407



A-935RB

**Folding Hex Key Set, Seven-Key, Metric Sizes**

- Two key positions (straight-out or right angle) for extra leverage
- Hex ends are square-cut for a secure full-depth fit and maximum contact with the hex socket to prevent slippage and stripping of the socket
- Handy sets fit in your pocket or tool box easily and help eliminate the lost key problem
- Includes 7 hex key sizes: 1-1/2 mm, 2 mm, 2-1/2 mm, 3 mm, 4 mm, 5 mm and 6 mm



A-70582

**L Style Ball End Hex Key Caddy Set Metric 9-Piece**

- L-style hex keys in convenient caddy sets
- Includes 9 sizes: 1.5, 2, 2.5, 3, 4, 5, 6, 8 and 10 mm
- Each set contains a unique locking feature and marked slots for each key
- Ball end works on angles up to 25-degrees
- Durable caddy keeps hex keys organized
- Top-grade alloy steel
- Heat-treated and tempered for added strength and durability
- Rust and corrosion resistance surfaces
- Extra length for hard-to-reach applications



A-BLMK10

**Connecting Bar, 7/8-Inch Round by 30-Inch Long**

- Provides extra leverage when positioning steel members and aligning bolt holes
- Forged fit-up bar is pointed on one end
- Chisel-end is at a 15-degree angle to give even greater leverage
- Manufactured from hardened steel for increased durability
- Other hex bar sizes sold separately



A-3248

## Adjustable Wrench, Extra-Capacity, 10-Inch

- Extra capacity allows use of a smaller size wrench to handle bigger jobs, especially in confined spaces
- Forged heat-treated alloy steel for light weight maximum strength and long life
- High polish chrome finish is rust resistant
- Precision-machined jaws are individually chosen and assembled by hand for smooth operation
- Contoured handles for comfortable use
- Knurl turns smoothly for easy operation
- Rail is ground for precision fit



A-507-10

## Adjustable Wrench, 16-Inch

- Versatile wrench fits all nuts and bolts to 1-1/2-Inch (38 mm)
- Eliminates the need for carrying several fixed-size wrenches
- Forged from select alloy steel with continuous-taper handle for aligning bolt and/or rivet holes
- Industrial black finish for corrosion resistance
- Precision-machined jaws are individually chosen and assembled by hand for smooth operation
- Heat-treated for long life
- Knurl turns smoothly for easy operation



A-3239

## 3/8-Inch Torque Wrench Square Drive 14-Inch Length

- Torque range of 10 to 100 foot pound (13.56 to 135.58 Nm)
- Micro-adjustable for increased accuracy
- Easy to read and adjust with quick release lever
- Stainless steel handle provides improved, more comfortable grip
- N.I.S.T. traceable calibration certificate meeting the ASME standard of +/-4-percent
- Made in the USA of imported and domestic components



A-57000

## Fish and Glow Rod Set, 25-Foot

- Extra durable, lightweight and available in a variety of lengths and flexibilities
- Five 1/4-Inch (6 mm) diameter fish rods and one 3/16-Inch (5 mm) diameter glow rod assemble to a full 25-feet (7.62 m)
- Five rods with durable 5/16-Inch diameter stainless steel connectors and one rod with 1/4-Inch diameter stainless steel connectors
- Bullet nose and hook attachments to attach and grab wires
- Protective Splinter Guard coating keeps hands free of fiberglass splinters
- Made in the USA



A-56325

## Fiberglass Fish Tape with Spiral Steel Leader, 50-Foot

- Strong S-Glass fiberglass fish tape material provides better pushing power and long life while maintaining its low-friction exterior and maneuverability
- Case design decreases payout effort and friction by optimizing the tape payout angle
- Slip-resistant housing geometry improves winding power and reduces binding
- Multi-position handle gives you a firm, steady grip as you pull or rewind the tape
- Durable 7-Inch spiral steel leader helps push through crowded conduit
- Descending laser etched markings in 1-Foot (0.3 m) increments allow you to more accurately measure conduit runs and the amount of tape left to pay out
- Polypropylene case and handle offer high impact resistance



A-56350

## Multi-Groove Fiberglass Fish Tape with Nylon Tip, 50-Foot

- Multi-groove fiberglass fish tape has a strong core for better pushing power while the grooves provide less surface area for smoother tape feeding
- Case design decreases payout effort and friction by optimizing the tape payout angle
- Slip-resistant housing geometry improves winding power and reduces binding
- Multi-position handle gives you a firm, steady grip as you pull or rewind the tape
- Updated non-conductive nylon tip is narrower for easier feeding and chamfered for less catch when pulling
- Durable fiberglass is longer lasting and maneuvers better in crowded conduit
- Polypropylene case and handle offer the maximum impact resistance



A-56382

## Curved-Claw Hammer Heavy Duty

- Durable plastic-alloy jacketing helps to protect neck from fraying and splintering if incorrectly struck or overstruck
- High-strength fiberglass shaft absorbs shock and keeps head tight
- Comfortable, perforated neoprene grip bonded to handle
- Curved claw gives maximum nail-pulling leverage



A-818-16



## Klein Kleeners® Hand Cleaning Towels

- Simple and convenient pre-moistened towels
- Powerful, yet gentle pumice-like cleaning action
- Quickly loosens, dissolves, and absorbs dirt and grease
- Features a natural citrus solvent that's gentler than petroleum-based hand cleaners
- For additional information, read the Material Safety Data Sheet for this product



A-51425

## Tradesman Pro™ Shoe Covers, Large

- High quality, durable nylon construction
- Water resistant
- High traction, slip resistant soles (exceeds 0.5 COF per ASTM D1894)
- Reusable; 6-9 month average lifespan with daily use
- Easy on and off
- Machine wash cold, air dry
- 1 black pair per package
- Proudly Made in the USA with Global Components



A-55488

## Tradesman Pro™ Standard Kneeling Pad

- 1-Inch thick, resilient NBR foam protects your knees
- Kneeling pad won't stay compressed, it bounces back to original form
- Built-in handle allows for convenient transport or hanging
- Closed-cell foam is resistant to petroleum and is silicone-free
- Use kneeling or standing; great for anti-fatigue
- Water repellent
- Indoor or outdoor use and hand washable



A-60135

## Tradesman Pro™ Large Kneeling Pad

- 1-Inch thick, resilient NBR foam protects your knees
- Kneeling pad won't stay compressed, it bounces back to original form
- Chamfered safety edge with orange stripes provides visual and tactile awareness of edge
- Large size allows you to move without moving the pad each time
- Built-in handle allows convenient transport or hanging
- Closed-cell foam is resistant to petroleum and is silicone-free
- Use kneeling or standing; great for anti-fatigue
- Water repellent
- Indoor or outdoor use; hand washable



A-60136

### Lightweight Gel Knee Pads

- Lightweight knee pads have slip resistant rubber caps to grip kneeling surface for enhanced stability and balance
- Pressure dispersed with gel and EVA foam that cushions the knee
- Fatigue reduced by gel design that also provides lightweight comfort and protection
- Bottom strap is webbed
- Top strap is elastic
- Cinch-tight straps provide comfortable, snug fit
- Clips hold tight and keep straps secure



A-60184

### Tradesman Pro™ Knee Pads

- Five layers of impact resistant material for protection and comfort
- For comfort: an inner fabric layer of neoprene, an over-sized impact-absorbing gel layer, a molded polyurethane foam layer
- For protection: a super-tough 600d outer fabric layer, a protective outer shell with stabilizing non-slip surface
- Single strap doesn't bunch behind your leg
- Quick-fasten buckle



A-55629

### Tool Tether, 10-Pound Maximum Load

- Keep your tools close at hand when working at height
- Maximum working capacity of 10-pounds (4.5 kg)
- Relaxed length of 32-Inches (812.8 mm)
- Stretched length of 60-Inches (1524 mm)



A-TT1

### Triple-Locking Tool Tether, 15-Pound Max

- Keep your tools close at hand when working at height
- Maximum working capacity of 15-pounds (7 kg.)
- Triple-locking carabiner for additional security
- Relaxed length: 32-Inches (813 mm)
- Stretched length: 51-Inches (1295 mm)



A-TT2

## Klein Cooling Towel

- Advanced PVA cooling technology
- Feels cooler than ambient air temperature
- Activates quickly; under a minute!
- Stays cool for hours
- Multi-use; reactivate several times
- 13-Inch x 29.5-Inch (330 mm x 749 mm)
- To activate or re-use, wet the towel and gently wring out the excess water
- Machine or hand wash with mild detergent; air dry only
- Store damp in storage tube with cap off for daily use



## Neck and Face Cooling Band

- This cooling band is designed using super evaporative performance knit fabric
- Secure fit and won't unravel with sewn elastic ends
- Anti-odor treatment for long lasting freshness
- Seamless, moisture-wicking fabric can be worn wet or dry
- When wet, cooling is instant and can last for hours
- UPF 50+ sun protection from harmful UV rays
- Versatile cooling band can be worn many ways
- Can be worn by itself or under a hard hat
- One Size Fits Most
- Reflective accents
- Machine washable
- Also available in High-Visibility Yellow (Cat. No. 60465)



Cat. No.	Description	Colour	Material	Overall Length
A-60439	Neck and Face Cooling Band	Blue	92% Polyester, 8% Spandex	50.8 cm
A-60465		High-Visibility Yellow		

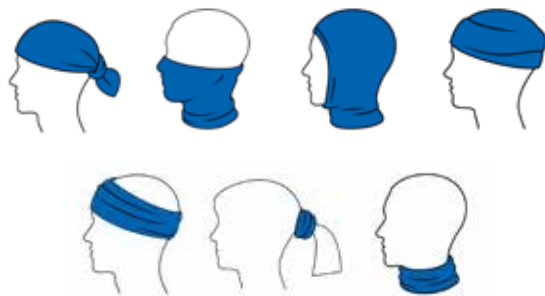

## Neck and Face Warming Half-Band, Black

- Top portion of warming band covers the face and has two layers of protection
- Moisture wicking knit fabric on top portion has anti-odor treatment for freshness
- 270-Gram fleece on bottom portion for warmth in cold conditions
- Secure fit and won't unravel with sewn elastic edge
- One size fits most
- Reflective accents
- Machine washable



**Tradesman Tumbler**

- Tumbler uses double wall vacuum insulated stainless steel to keep liquid cold up to 12 hours and hot up to 4 hours
- Unique double-thread lid design allows easy twisting with gloves on or off
- Flip-top lid locks to form a spill-resistant seal for transport
- Textured silicone outer sleeve enables a slip-resistant grip with gloved or ungloved hands
- Slip-resistant bottom pad friction-grips to most surfaces
- Removable rare earth magnetic lanyard helps secure tumbler to metal objects
- Made from stainless steel and other BPA-free food grade materials



A-55580

**Contractor Pack**



A-CONPACK1

Kit Contains		
Cat. No.	Description	Qty
A-55601	Klein Tradesman Pro Lunch Cooler	1
A-31737	Klein Folding Plaster Saw	1
A-NCVT-1	Klein Non Contact Voltage Tester	1
A-60439	Klein Cooling Neck Band	1
A-56048	Klein Rechargeable Slimline Headlamp	1
A-32243-INS	Klein 100mm VDE Insulated Screwdriver 4.0 Flat Tip	1
A-32259-INS	Klein 100mm VDE Insulated Screwdriver Phillips #2	1
ALCB725/100	Alco Bugle Head Screws 100 pack 7g x 25mm	1 pack
ALCTIE185B	Alco Black Cable Ties 100 pack 199mm x 4.6mm	1 pack



## Zipper Bag, Canvas Tool Pouch 12.5 x 7 x 4.25-Inch

- Tool Bag made of No. 10 canvas, with strong zipper
- No. 10 canvas used to give this tool pouch added durability
- 12.5-Inch x 7-Inch x 4.25-Inch (318 x 178 x 108 mm)
- Heavy-duty zipper keeps canvas bag securely closed



A-5139

## Zipper Bag, Cordura Nylon Tool Pouch, 12-1/2-Inch

- This Tool Pouch is constructed of Cordura® fabric, a high-performance material resistant to abrasions, tears and scuffs
- Tool Bag's heavy-duty nylon zipper keeps items secure
- Convenient storage for pliers, wrenches, screwdrivers, nut drivers, other tools and spare parts
- Cordura® is a registered trademark of INVISTA for durable fabrics



A-5139B

## Zipper Bag, Top-Grain Leather Tool Pouch, 12-1/2-Inch

- Brushed cowhide leather construction on this tool pouch provides needed durability
- Convenient zipper bag for pliers, wrenches, and other tool storage
- Premium-quality stitching increases reliability
- Heavy-duty zipper keeps canvas bag securely closed



A-5139L

## Zipper Bags, Canvas Tool Pouches Olive/Orange/Blue/Yellow, 4-Pack

- These Tool Pouches are proudly Made in the USA
- Tool Bag Set includes four assorted colors: olive, orange, royal blue, and yellow
- Made of heavy-duty No. 10 canvas with brass zipper
- Convenient storage for pliers, wrenches, screwdrivers, nut drivers and other tools and spare parts



A-5140

## Zipper Bags, Canvas Tool Pouches Brown/Black/Gray/Red, 4-Pack

- Tool Bag Set includes 4 assorted colors: red, gray, black and brown
- Heavy-duty water resistant No. 10 canvas makes these tool pouches strong with brass zipper to keep items secure
- Convenient storage for pliers, wrenches, screwdrivers, nut drivers, other tools and spare parts
- Bank deposit bag for cash
- Made in the USA



A-5141

## Zipper Bag, Canvas Tool Pouch, 10-Inch

- Brass grommet on tool pouch easily attaches to tool belt or clip
- Zipper bag provides convenient storage for wire nuts, connectors and other consumables
- 10-Inch (254 mm) long x 8-Inch (203 mm) high x 3-1/2-Inch (89 mm) wide bottom
- Constructed with tough No. 8 canvas for added durability
- Heavy-duty zipper keeps canvas bag securely closed
- Natural canvas coloring makes identification easier



A-5539NAT



A-5539YEL



A-5539BLU



A-5539RED

## Zipper Bag, Stand-Up Tool Pouch, 2-Pack

- Tool pouch features reinforced bottom of 2520 ballistic material to prevent tools and parts from poking through
- Stand-up bottom on zipper bag allows for stability when standing and easy access when open
- Colored interior to see items better
- Bags are different sizes and colors to help with organization
- Body of the bags are of tough 1680d ballistic material
- Connect bags with a carabiner (not for human support)
- Two-pack includes a 6-1/2-Inch tall (165 mm) orange bag and a 7-1/2-Inch tall (191 mm) gray bag



A-55470

## Tradesman Pro™ Tool Pouch, 15 Pockets, 11.5 x 4.5 x 10-Inch

- Tool Pouch with heavy duty reinforced bottoms
- Small Tool Bag features multiple pockets of various sizes, plus a tape thong
- Great for carrying a mix of tools and job site consumables
- Includes a padded shoulder strap for easy carrying, to use without a belt
- Tunnel loop fits 2-Inch (51mm) belts



A-5243

---

## Tradesman Pro™ Laptop Backpack / Tool Bag, 25 Pockets, Black Polyester

- Backpack fits laptops up to 3-Inch thick
- Separate compartment keeps laptop protected from tools
- Hard, molded front pocket protects safety glasses
- Tough, durable molded bottom protects from the elements
- Orange interior for easy tool visibility
- Organizer pocket for pens, phone, cables and more
- Water resistant 1680d ballistic weave for durability



A-55439BPTB

---

## Tradesman Pro™ Tool Station Tool Bag Backpack with Worklight

- Backpack with 21 pockets and large interior for maximum tool storage
- Includes removable Flashlight with Worklight; A bright magnetic flashlight and broadcasting work light in one tool
- Elastic loop holds Worklight for hands-free illumination of backpack interior when working in low light areas
- Front of backpack unzips halfway for quick tool access or fully extends for workstation access
- Made of water resistant 1680d ballistic weave material for durability
- Orange interior for easy tool visibility
- Extra padding on the shoulder straps and back for carrying comfort
- Adjustable chest and lower straps for a customized fit
- Front zipper pocket for small items
- Exterior organization includes side elastic pouch for water bottle, tape measure clip, and tape thong



A-55655

## Deluxe Tool Bag, Black Canvas, 13 Pockets, 16-Inch

- Tool bag is constructed with heavy-duty No. 8 black canvas
- Tool tote's 13 interior pockets are perfect for tool organization
- Detachable shoulder strap can be adjusted for a perfect fit
- Stitched and riveted leather handles for extra comfort and strength
- Moisture-resistant vinyl bottom
- Steel frame mouth with hinge for rugged use
- Rivet-reinforced for durability
- Non-scratch studs on base protect against wear



A-510216SPBLK

## Tool Bag, Tradesman Pro™ Wide-Open Tool Bag, 42 Pockets, 16-Inch

- This tool bag has a stay-open top for unobstructed tool access
- Tool organizer's orange interior and wider opening makes it easier to find the right tool
- Large interior zipper pocket
- Inside is equipped with various sized pockets for tools and gear
- Multiple exterior front and back pockets for quick access
- Outside has side mesh pockets and a metal tape measure holder
- 1680d ballistic weave for durability
- Shoulder strap with extra padding and handles
- Fully-molded bottom protects from the elements



A-55469

## Tradesman Pro™ Tool Master Rolling Tool Bag, 19 Pockets, 22-Inch

- Rolling Tool Bag's rugged 8-Inch (203.2 mm) wheels provide high clearance to easily roll over rough terrain
- Tool bag has a hard top that allows for stacking materials on top
- Load tested up to 250-Pounds (113 kg)
- Twist-lock Klein LED Light (55437) or Wireless Speaker (AEPJS1) on front mount (items sold separately)
- Heavy-duty telescoping handle for easy maneuvering on the jobsite
- Exterior webbing and D-rings allow for bungee cord attachment and other add-ons
- Metal latches keep lid closed
- Double lock hasp on hard top fits padlock so nothing goes missing (padlock not included)
- Constructed with durable Water Resistant 1680d Ballistic Weave material
- Total of 19 interior and exterior pockets for maximum tool storage
- Wide open interior accommodates large tools
- Orange interior for easy tool visibility
- Hard top is contoured to hold cell phone, beverages and small parts



A-55473RTB

## Canvas Bucket, All-Purpose with Swivel Snap and Drain Holes, 12-Inch

- Canvas Bucket with 150-pound (68 kg) Max Load Rating
- Web strap extends down the side of the tool bucket for added strength
- Heavy duty plastic bottom with drain holes
- Made in the USA
- Tool Bucket measures 12-Inch (30.5 cm) diameter and 15-Inch (38.1 cm) high



A-5109SLR

## Leather Tool Pouch with Knife Snap, 5-Pocket

- Stitched and riveted leather construction for long life
- Has a large utility pocket, two pliers pockets and two screwdriver pockets
- Includes a knife snap
- Slotted to fit belts up to 2-Inches (51 mm) wide



A-5126

## Tool Pouch, 6 Pocket, Tunnel Loop

- Features a large utility pocket, three pliers pockets and two screwdriver pockets
- Stitched and riveted leather construction for long life
- Includes a knife snap
- Tunnel loop fits belts up to 2-1/2-Inch (64 mm) wide
- Assembled in USA of U.S. and imported components



A-5127T

## 8-Pocket Tool Pouch

- Soft, pliable, black leather is durable and moisture-resistant
- Roomy pouch for electricians, service techs, and maintenance workers
- Five large utility pockets and three pockets for screwdrivers and pliers.
- Tape rule holder on the front
- Fits most belts up to 2.5-Inch (6.4 cm) wide
- Riveted and stitched for extra durability
- Heavy-duty chain tape thong securely fastened with a rivet
- Made in the USA



A-5178



### General-Purpose Belt, Medium

- Made of strong, heavy-duty leather
- Removable single-tongue buckle held by two heavy-duty snaps
- Belt is 1-1/2-Inches (38 mm) wide
- Versatile tool belt helps keep pouches and holders together



A-5202M

### Tool Belt with Quick Release Buckle, XL

- Extra Large fits 38-Inch to 58-Inch (965 to 1473 mm) waist sizes
- Features a forged, quick-release buckle for emergency situations where the user has to quickly disengage the belt (ie, working over water or in grain elevators)
- Must be worn over the users harness and clothing so it will drop free when released
- Belt is made of a mildew-resistant blend of cotton/polyester webbing for comfort and strength



A-5425XL

### Heavy-Duty Embossed Tool Belt, Medium

- Strong, heavy-duty leather
- Equipped with a double-tongue buckle
- Embossed with a basket-weave pattern for added style
- Fits waist sizes 36-Inch to 44-Inch



A-5415

### Bull Pin Holder Tunnel Connection

- Leather construction
- Holder for Klein and all standard bull pins
- Riveted to assure long life
- Easily attachable to a tool belt for convenient access



A-5417T

## Connecting Bar Holder with Lock Collar

- Designed for use with Klein Tools 7/8-Inch round connecting bars (Cat. Nos. 3248 and 3246)
- Made of leather
- Tunnel loop allows for weight distribution on belt
- Fits belts up to 3-1/2-Inches wide
- Made in the USA



A-5459SLVR

## Erection Wrench Holder Tunnel Connection

- Riveted, leather construction for long life
- Slots for two erection wrenches
- Holds erection wrenches and adjustable head construction wrench Cat. No. 3239
- Saves time on the job by keeping tools accessible
- Made in USA
- Convenient belt loop
- 6-Inch length



A-5459T

## Camo Knife Holder

- Holds up to a 4.5-Inch folded knife
- Metal clip for belt or pocket
- Magnetic flap closure
- Constructed of 1680d Ballistic weave material for durability
- REALTREE® and REALTREE XTRA® are registered trademarks of Jordan Outdoor Enterprises, Ltd



A-55561

## PowerLine™ Series Electrician Tool Pouch, 18-Pocket

- Tool Pouch with 18 pockets to carry a variety of tools, includes a large utility pocket with a divider
- Pouch includes convenient chain tape thong
- Constructed of double layered, washable 1000 denier Cordura® fabric
- Double stitched and rivet reinforced for strength and durability
- No break-in period, forms and hugs the body for easy, daily wear
- Exceptional resistance to abrasion, punctures and tearing
- Cordura® is a registered trademark of INVISTA for durable fabrics



A-5719

**PowerLine™ Combo Set, 4-Piece, Large**

- Various pocket sizes increase tool accessibility when working
- Padded tool belt fits comfortably for all-day use
- Constructed of durable layered 1000 denier washable Cordura® fabric
- Oversized pockets and reinforced bottom for extra carrying capacity



A-5709L

**Assembled Iron Conduit Bender 3/4-Inch EMT**

- Exclusive design reduces rippling and ovaling of conduit
- Traditional Benfield® head design accurately and consistently performs common bends such as Stub Ups, Offsets, Back-to-Back and Saddle Bends
- Bold cast-in symbols, degree scales, multiplier scales and center of bend marks help save time on the job
- Interior hook surface prevents conduit from rolling or twisting during bends
- Interior clamp securely holds conduit while cutting with hacksaw
- Wide foot pedal provides excellent stability, leverage and comfort
- Features angled grooves for extra traction
- Easily visible arrow for ease of alignment on conduit marks
- High-strength steel handle features a swaged end for inserting conduit to correct overbends
- Orange handle is easy to spot on the job site



A-56204

**Wire Marker Book, 1-48**

- More pages of the frequently used low numbers (1-24)
- Easily dress each side of the panel with separate pages of odd or even markers
- Larger, easy-to-read print on 0.25" x 1.5" labels
- Each page is perforated so that a third, two-thirds or entire the page can be easily detached
- Label can be easily split for thin wire
- Strong tack for lasting adhesion on oily wires
- Markers are a vinyl coated white cloth, 8 mils thick
- Made in the USA



A-56250

## LED Flashlight with Worklight

- Bright, focused flashlight and broadcasting work light in one tool
- LED light features a strong magnet for secure, hands-free illumination
- Glow ring tip charges while the light is on and allows for easy retrieval in the dark and in your tool bag
- Waterproof (IP67) and dustproof
- Flashlight: 235 lumens for 6 hours; Worklight: 100 lumens for 12 hours
- Pocket clip for easy, convenient access
- Aluminum body with cushion-grip handle
- 3 x AAA batteries included



A-56028

## Rechargeable Headlamp with Strap, 400 Lumen All-Day Runtime, Auto-Off

- Rechargeable 400 lumen Auto-Off LED Headlamp has 3 modes: All-on/Boost at 400 lumens for 4 hours, Spotlight at 200 lumens for 12 hours, and 22 hour runtime Floodlight at 100 lumens
- Headlamp automatically turns off after 3 minutes in bright light via auto-sensing technology, extending battery life (feature can be disabled by holding the power button for 10 seconds)
- Battery gauge indicates level of battery life with colored LED lights
- Smartly designed headlamp bracket also attaches directly to Klein® Hard Hats (those equipped with bracket system)
- Slim profile with pivoting mount to allow up to a 64-Degree lighting angle
- Adjustable woven fabric strap with silicone grip secures to headlamp onto head, hard hat, or cap
- Light can be easily removed from bracket for recharging
- Rechargeable via micro-USB port (cable included)
- Durable headlamp: drop-test rating of 6-Foot, dust and water resistant



A-56048



**Flex Bit 54-Inch Extension 1/4-Inch Shank**

- Connects to the end of a flex bit and extends the length
- For use with flex bits 3/4-Inch (19 mm) and larger
- Connection diameter is 5/8-Inch (16 mm)
- Ideal in applications where additional drill bit length is required, such as drilling between walls or several rafters



A-53722

**Flex Bit Auger 3/4-Inch by 72-Inch**

- Used to drill holes through wood within a wall
- Tapered back for easy bit retrieval
- Spring steel shaft resists deformation
- Screw point tip pulls the bit through wood
- Hole in tip allows for use with wire or cable pulling grip
- Comes with a reusable protective case for the auger head when the bit is not in use



A-53751

**DIGITAL CLAMP METERS**







## Digital Clamp Meters

New Capabilities offered at the same cost!

- Rugged industrial design – improved durability, look and feel
- Integrated NCV tester on all meters with audible and visual indicators
- Test lead holder on side of clamp for hands-free operation
- True RMS added to CL220
- Improved temperature accuracy on all models
- Upgraded lantern-style test-leads on all models
- Larger jaw opening – now 3.51cm (1.38")
- New magnetic hanger without a strap clips directly to the back of meters (sold separately)













Features	A-CL390	A-CL320	A-CL220	A-CL120
Drop Protection	2m (6.6ft)	2m (6.6ft)	2m (6.6ft)	2m (6.6ft)
Ingress Protection	-	-	-	-
Safety	CAT III 600V	CAT III 600V	CAT III 600V	CAT III 600V
AC Voltage (Volts)	600V	600V	600V	600V
DC Voltage (Volts)	600V	600V	600V	600V
AC + DC Voltage	-	-	-	-
AC Current (Amps)	400A	400A	400A	400A
DC Current (Amps)	400A	-	-	-
Ohms (Resistance)	40MΩ	40MΩ	20MΩ	20MΩ
AC Millivolts	●	-	●	●
DC Millivolts	●	●	●	●
DC Microamps	●	●	-	-
True RMS	●	●	●	-
Audible Continuity	●	●	●	●
Backlight	Reverse Contrast Display	●	●	●
Temperature	-40° – 1000°C	-40° – 1000°C	-40° – 1000°C	-
Differential Temperature	-	-	-	-
Digital Temperature Calibration	-	-	-	-
Low Impedance	-	-	-	-
Low-Pass Filter	-	-	-	-
Inrush Current	-	-	-	-
Non-Contact Voltage Testing	●	●	●	●
Auto Ranging	●	●	●	●
Range Hold	●	●	●	●
Data Hold	●	●	●	●
Diode Test	●	●	-	-
Capacitance Test	4000 μF	4000 μF	-	-
Frequency / Duty Cycle	10Hz – 60kHz	10Hz – 60kHz	-	-
Max / Min	●	●	MAX only	MAX only
Relative Mode	●	-	-	-
Magnet	Available As Accessory	Available As Accessory	Available As Accessory	Available As Accessory
Worklight	-	-	-	-
Auto-Power Off	●	●	●	●
LCD Display Count	4000	4000	2000	2000



# NON-CONTACT VOLTAGE TESTERS

- Detects voltage with simultaneous visual and audible voltage indicators
  - Lightweight, compact tool with pocket clip provides convenient storage and quick access
  - Auto power-off feature conserves and extends battery life
  - Screw-thread battery cap with O-ring
  - CAT IV 1000V rating provides expanded operation and protection
- **A-NCVT-2P** is a non-contact voltage tester that detects 12 to 1000V AC and indicates the presence of voltage in cables, cords, circuit breakers, light fixtures, switches, outlets and wires as well as AC voltage in doorbells, thermostats, low voltage lighting and irrigation systems. Includes both visual and audible signals.
  - **A-NCVT-3P** is a non-contact voltage tester with an integrated flashlight. The voltage sensor detects 12 to 1000 VAC and indicates the presence of voltage in cables, cords, circuit breakers, light fixtures, switches, outlets and wires as well as AC voltage in doorbells, thermostats, low voltage lighting and irrigation systems. Includes both visual and audible signals. The NCVT-3P is rugged enough for any job site.
  - **A-NCVT-6** is a non-contact voltage tester with an integrated laser distance meter. It can detect voltage over the full-range from 12 to 1000 VAC and can measure distances from 2-Inch (51 mm) up to 66-Feet (20 m). The laser distance meter functions independently from the NCVT with a simple-to-use intuitive interface. Easy, single-button changes between voltage detection and laser distance measurements.



Features	A-NCVT-2P	A-NCVT-3P	A-NCVT-6
Description	Dual Range	Dual Range with Flashlight	Voltage Tester with Laser Distance Meter
 Drop Protection	2 m	2 m	2 m
 Ingress Protection	IP54	IP67	IP40
 Safety	CAT IV 1000V, CE	CAT IV 1000V, CE	CAT IV 1000V, CE
 Voltage	Mode 1: 12-1000V AC Mode 2: 70-1000V AC	Mode 1: 12-1000V AC Mode 2: 70-1000V AC	12-1000 VAC
 Frequency Range	50-500Hz	50-500Hz	50 - 500 Hz
 Audible and Visual Alarms	●	●	●
 Auto-Power Off	●	●	●
 Temperature	-	-	-
 Laser	-	-	Class 2 Distance Meter
 Flashlight	-	●	-
 Backlight	-	-	●
 LCD Display	-	-	● Reverse Contrast
 Batteries	2 x AAA	2 x AAA	2 x AAA
Overall Length	148 mm	148 mm	164 mm
Weight	48 g	51 g	72 g



## Magnetic Hanger

- Strong magnet attaches securely to metal surfaces for hands-free use
- Clips securely into back of rubber boot
- For use with various electrician multimeters including Klein Tools' Professional Series: MM1000, MM1300, MM2000, MM2300, MM5000 and MM6000
- Durable nylon weave resists wear and tear
- Has a secure Velcro® loop & hook
- Velcro® is a registered trademark of Velcro Industries B.V



A-69190

## Heavy-Duty Alligator Clip Test Leads

- Standard banana-type inputs compatible with most multimeters and clamp meters
- Heavy-duty alligator clips attach to wires and other conductors
- Perfect for insulation resistance testing
- Alligator clip jaw: 15 mm opening with protective PVC cap
- Includes 1 pair of Universal Test Leads with banana plug to heavy-duty alligator clip
- Safety Rating: Category III 1000V and Category IV 600V
- Leads are 40-Inch (102 cm) long 18 AWG double insulated wire



A-69420

## Rare Earth Magnetic Hanger, no Strap

- Magnetic Hanger allows the user to safely work hands-free
- Constructed with powerful rare earth magnets
- Clips directly onto the back of the meter with no strap
- For use with Klein Tools Clamp Meters CL220, CL120, CL320, CL390, CL450, CL600, CL700, CL800, CL900, and Multimeters
- View measurement readings at eye-level by attaching to ferromagnetic surfaces
- Compact size with powerful hold
- Easy to clip on and off
- Convenient, compact addition to meter



A-69445

### Insulation Resistance Tester

- Voltage Tester tests insulation resistance up to 4000MΩ at 125V, 250V, 500V, and 1000V DC
- Megohmmeter with test and lock buttons for simple insulation testing
- Warning alarm and high voltage icon for detection of voltage
- Measures up to 1000V AC/DC, resistance, and continuity
- Automatic ranging True Root Mean Square (TRMS) technology for increased accuracy
- Backlit display with bar graph, Auto-power off, High Voltage, Max/Min, and Hold icons
- Low battery indicator with easily replaceable battery and fuse
- Built-in stand and optional magnetic hanger for hands free operation
- Test verification of conformity to EN61557-1,-2,-4
- CAT IV 600V and CAT III 1000V safety rating
- Includes Right Angle Test Leads and Heavy-Duty Alligator Clip Test Leads



A-ET600

### Pinless Moisture Meter

- Pinless Moisture Meter with electromagnetic field (EMF) technology allows for nondestructive detection of moisture content in building materials
- Drywall tool detects moisture content up to 3/4-Inch (19 mm) deep
- Easy viewing with bright reverse-contrast display
- Nine LED bars indicate moisture range
- Easy-to-select materials with mode button; drywall, masonry, hardwood, and softwood
- Hold, Low battery, and Auto-Power off functions
- Built to withstand a 6.6 foot (2 m) drop
- Includes detector, 9V battery, and instruction manual



A-1T140

### WiFi Borescope

- WiFi Borescope transmits and displays video and images directly to your smartphone up to 30 Feet (9 m) away
- Waterproof 9 mm camera has 6 on-board, adjustable LED lights and outputs high-quality 640 x 480 images
- Tough, armored 6-Foot (1.8 m) long waterproof camera gooseneck maneuvers around obstacles while maintaining rigidity
- Battery status indicator tracks the charge level of the lithium-ion battery
- Increase and decrease camera LED output either on the Borescope or in the App
- The App not only acts as a display, but stores and shares images and videos via text or email
- Includes convenient pocket clip, USB charging cable, hook attachment, carrying case, and instructions
- The Klein Borescope App is available free at the App Store® for iPhone® users and Google Play® for Android® users



A-ET20

## AC/DC Voltage/Continuity Tester

- Voltage tester automatically selects voltage or continuity; automatically powers on when any measurement is attempted
- Backlit LCD display
- CAT IV 600V modern solid-state design for safety
- Tests GFCI protected circuits
- Uses standard replaceable multimeter test leads
- Features built-in test lead holders on back of meter
- Integrated flashlight
- 9.8 ft. (3 m) drop protection
- IP53 dust and water resistant



A-ET250

---

## AC/DC Voltage/Continuity Tester

- Automatically selects voltage or continuity; automatically powers on when measurement is attempted
- Backlit LCD display
- CAT IV 600V (CAT III 690V)
- Uses standard replaceable multimeter test leads
- Features built-in test lead holders on back of meter
- Integrated flashlight
- 9.8-Foot (3m) drop protection
- IP53 dust and water resistant



A-ET260

---

## Digital Angle Gauge and Level

- This Digital Angle Gauge and Level can measure or set angles, check relative angles, or can be used as a digital level
- High visibility reverse contrast display improves visibility in dimly lit work environments
- Strong magnetic base to attaches to conduit, pipes, saw blades, vents, ducts, and other ferromagnetic surfaces
- V-groove edges enable optimal alignment on conduits and pipes for bending and alignment
- 0 to 90-Degree and 0 to 180-Degree measurement ranges facilitate multiple and diverse applications
- 0 to 180-Degree range is useful when accounting for kickback in pipe bending applications when bending to 90-Degree or more
- Display auto-rotates when upside-down for easy viewing
- Water and dust resistant with rating of IP42
- Soft carrying case and two AAA batteries included



A-935DAG



**Rechargeable Thermal Imager**

- Thermal Imager has over 10,000 pixels to troubleshoot hot and cold spots
- Adjustable emissivity from 0.10 to 0.99
- Store and share images with optional microSD® Card (sold separately)
- User selectable high and low temperature alarms from -4 to 752-Degree Fahrenheit (-20 to 400-Degree Celsius)
- Select color palettes to best capture the event
- Rechargeable lithium-ion battery
- Includes thermal imager, micro-USB charging cable, carrying case, and instructions



A-TI250



**Cable Tester Kit with Scout® Pro 3 Tester, Remotes, Adapter, Battery**

- Cable tester tests voice (RJ11/12), data (RJ45) and video (coax F-connector) terminated cables with clearly defined results
- Measure cable length up to 2000 feet (610 m)
- Test for Open, Short, Miswire or Split-Pair faults
- Backlit LCD screen displays cable length, wiremap, cable ID and test results
- Trace cables, wire pairs and individual conductor wires with multiple style tone generator (requires analog probe Cat. No. VDV500-123; sold separately)
- Hub blink mode to identify port location on a hub or a switch
- LanMap™ and CoaxMap™ Location Remotes (5 each) map and ID multiple cable runs in a single step
- Includes voltage warning, shield detection, auto power off, low battery indicator and a self-storing remote
- Auto Power-off feature to conserve battery life (9V included)
- Kit includes: Scout® Pro 3 Tester, (1) self-storing remote, (5) LanMap™ RJ45 locator remotes, (5) CoaxMap™ F-connector locator remotes, (1) coax F-connector, manual and 9V battery



A-VDV501-851

## Probe-PRO Tracing Probe

- Traces non-energized wiring when used with Toner-Pro Tone Generator (VDV500-063, sold separately)
- Responsive, durable, replaceable non-metallic, conductive tip
- Work light for use in dark spaces
- 3.5 mm headphone jack for noisy environments (headphones not included)
- Terminal block on probe to confirm the toned pair has been located
- Tool-less, twist-and-lock replacement tip (VDV999-068) available
- One push power button with power-on LED indicator - no need to hold button down
- Auto power-off
- Low battery indicator
- 4 x AAA batteries included
- Includes a loop for a lanyard
- Works with Klein's Scout® Pro, Lan Scout®, Jr. and Commander™ series of testers



A-VDV500-123

## Tone & Probe Test and Trace Kit

- Simple tone generator and wire tracing probe for non-active wire runs
- Responsive probe with durable, non-metallic, conductive tip
- Alligator clips for unterminated wires
- RJ45 to RJ45 test cable
- Toner and probe together perform pin to pin wire map test
- Work light on probe tip for use in dark spaces
- Adjustable volume control
- AAA batteries (included)
- Replaceable test cables available (Cat. No. VDV770-855)
- Headphone jack for noisy environments (headphones not included)



A-VDV500-705

## Tone & Probe PRO Kit

- Includes a professional grade tone generator and tracing probe for non-energized wiring
- Toner-Pro features 5 distinct tone cadences, transmits 1,000+ feet
- Rugged Angled Bed of Nails (ABN) clips securely attach to wires
- RJ11 plug easily connects to telephone and RJ45 data jacks to tone wire pair
- Toner-Pro tests for continuity and polarity with results indicated by clearly labeled LEDs
- Probe-Pro features 3.5 mm headphone jack for noisy environments (headphones not included)
- Responsive probe with durable non-metallic, replaceable conductive tip (VDV999-068) - sold separately
- Work light on probe tip for use in dark spaces
- Terminal block on probe to confirm the toned pair
- Each tool includes 4X AAA batteries
- Custom, padded, divided, zipper pouch for convenient storage (VDV770-500) included with kit



A-VDV500-820

## Dual Cartridge Radial Stripper

- Designed for high-volume, multiple-type cable preparation environments
- Two "active" stripping cartridge-bays and third "storage" cartridge-bay
- One-piece construction ensures precise stripping and never requires adjustment
- Large finger loop promotes rotation during use
- Cartridges snap in from both sides for left or right-handed operation
- F-Connector "nest" assists with cable insertion
- Durable high-carbon steel cartridge cutting blades are ground and honed for long life
- Bright, highly visible color for easy identification
- Durable Delrin® resin for outstanding wear
- Delrin® is a registered trademark of DuPont
- Replacement cartridges available
- 2-level coaxial preparation of 5/16-Inch x 1/4-Inch (7.9 mm x 6.4 mm)
- Strips outer jacket of Unshielded Twisted-Pair (UTP) cables (category 3, 5, 5e and 6), 1-level preparation



A-VDV00-801-SEN

## Compact Compression Crimper, F-Connector

- Advanced do-it-yourselfer tool for fast, reliable F-connector installation
- Fixed plunger allows quick, easy insertion and removal of cable and connector
- Accepts many common F-connector compression fittings
- Spring loaded return increases user comfort and ease of use
- Yellow and black grips enhance comfort and visibility and allow quick identification
- Steel body with black-oxide finish for corrosion resistance and durability
- Compact tool with integrated handle lock
- Overall length: 5.6 -Inch (142 mm)



A-VDV212-008-SEN

## Ratcheting Data Cable Crimper / Stripper / Cutter

- Ratcheting crimper provides fast, reliable modular-crimp connector installation for voice and data applications
- Cuts, strips, and crimps pair-conductor cables (round STP/UTP and flat-satin phone cable) all in one tool
- Crimps 4, 6, and 8 position modular connectors (RJ22, RJ11/RJ12, and RJ45)
- Steel body with black-oxide finish for excellent performance and durability
- Crimping dies are precision ground from high-carbon steel
- Designed for Western Electric (WE)/Stewart Stamping (SS)-type modular connectors
- Ratchet safety-release and a blade-guard on cutting and stripping knives reduce risk of injury
- Full-cycle ratchet mechanism prevents the release of the connector prior to full compression
- Yellow and black grips enhance comfort, visibility, and allow quick identification
- Three crimping dies (8-position, 6-position and 4-position)
- Cable parameters: 28-22 AWG (.08 - .34 mm<sup>2</sup>) flat or round; solid or stranded telephone and data
- Not for use with AMP® connectors
- AMP® is a registered trademark of TYCO, Inc.
- Replacement blade set available (Cat. No. VDV999-064)
- Additional safety features to protect fingers



A-VDV226-011-SEN

## Data Cable Crimping Tool for Pass-Thru™, Compact

- Modular crimp-connector installation tool for voice and data applications with Pass-Thru RJ45 connector plug
- Compact Crimper crimps and trims Klein Tools RJ45 Pass-Thru™ connectors onto paired-conductor cables (round STP/UTP cables)
- On-tool wiring guide helps minimize wiring errors
- Fast, reliable RJ45 Pass-Thru™ modular crimper installs connectors for data applications
- Use with Klein Tools Pass-Thru™ Connectors
- Not for use with standard (non Pass-Thru™) connectors
- Replacement blades available (Cat. No. VDV999-078)



A-VDV226-005

## Network Cable Tester, LAN Explorer® Data Cable Tester with Remote

- Cable tester with single button testing of RJ11, RJ12 and RJ45 terminated voice and data cables
- Tests CAT3, CAT5e and CAT6/6A cables
- Fast LED responses indicate cable status (Pass, Miswire, Open-Fault, Short-Fault, and Shield)
- Test remote stores securely in tester body
- Compact tester easily fits in your pocket
- Auto Power-off feature to conserve battery life (9V included)
- Low battery indicator
- Replacement remote (VDV999-150) available (sold separately)



A-VDV526-100

## Cable Tester, Coax Explorer® 2 Tester with Batteries and Red Remote

- Cable tester tests and maps coaxial cable
- Simple push-button operation for wire tracing
- Easy to read LED panel indicates PASS, OPEN, or SHORT conditions and simplifies cable identification
- Remote #1 (red) is included with this tester; additional remotes also available (Cat. No. VDV512-110)
- Color coded push-on remotes allow for up to four cables to be tested and mapped (sold separately)
- Upgrade Remote Kit VDV512-110 (sold separately), includes holder with 4 remotes and F adapter
- Uses 2 replaceable AAA batteries
- Note: Does not work through cable splitters



A-VDV512-100

## 110 Punchdown Blade

- Compatible with Impact Punchdown Tool (VDV427-013), and other bayonet style (twist and lock) socket punchdown tools
- Terminate cable in variety of cross-connect panels, blocks and keystone jacks
- Induction hardened high carbon steel for durability and long life
- Reversible blades with termination/cutting ends and termination only ends
- Precision ground cutting-edge for clean, precise wire termination
- Also for use with other bayonet style (twist and lock) socket punchdown tools
- Blade is two inches long



A-VDV427-015-SEN

## Universal F Compression Connectors RG6/6Q 10-Pack

- The patented universal sleeve technology F-Connector installs up to five times faster than standard coax compression connectors
- Fits most diameter variations within a cable series and difficult to work with mult-shield and plenum cables
- Provides excellent holding power and signal strength
- Patented viewing windows in sleeve aid in proper seating
- Professional-grade with premium quality, solid brass construction
- Elegant dark nickel-plated finish for indoor use
- Also available in a pack of 50 (Cat. No. VDV812-612)



A-VDV812-606

## Weatherproof F-Compression Connectors RG6 10-Pack

- Dual O-ring to seal out moisture
- Color-coded application band for easy identification of cable compatibility
- Fits most RG6 cables
- All metal construction
- Satellite provider approved
- Also available in a pack of 50 (Cat. No. VDV812-624)



A-VDV812-623

## Pass-Thru™ Modular Data Plugs, CAT5e, 200-Pack

- Klein exclusive Pass-Thru™ Connectors provide fast, reliable connector installations for data applications
- CAT5e Cable easily passes through connector to visually ensure that wires are in the correct order for consistent and secure terminations
- 50µ inch gold plating on all contact surfaces
- Category 5e performance per EIA/TIA B.2. FCC compliant, UL rated, RoHS compliant
- For use with Klein Tools Pass-Thru™ Modular Crimper VDV226-110
- 200-Pack
- 8 position, 8 contact Pass Through style data plug for solid or stranded cable
- Max diameter for CAT5E Pass-Thru™ Connectors is 0.04-Inch (1.01 mm)



A-VDV826-762



MUMME TOOLS  
**ROOFING TOOL**  
 TURN UP TURN DOWN

**10X** faster than traditional sheet metal gripping tool

Provides quick & easy access to weathering roof sheeting without kinking or tearing

Perfect for TL-5 roof profile and can be used on many other roof profiles

**TURN UP FUNCTION**

- 110mm head width
- Used to prevent water entering the roof cavity
- Simply insert the flat end onto roofing sheet and turn it up

**TURN DOWN FUNCTION**

- 105mm head width
- Used to prevent water creeping back under the roof sheet
- Simply insert the bent end onto roofing sheet and turn it down



Product Code	Description	Length	Weight	Barcode
5TUTD	Roofing Turn Up/Turn Down Tool	320mm	0.55kg	9314572015487

## Adaptable PVC Enclosures

- Professional wide-ranging solution for junction boxes and control enclosures
- IP56, Dust and water resistant
- High impact resistance
- Fully insulated
- Corrosion free
- Sealed cover
- Grey colour
- Threaded entries and knockouts for conduit and cable entry
- Compliance with AS 1939-1990
- ALCEZIBOX0 supplied with: 2 x 20mm & 1 x 25mm screwed adaptors



Cat. No.	Height	Width	Depth
ALCEZIBOX0	85 mm	85 mm	62 mm
ALCEZIBOX1	105 mm	105 mm	72 mm
ALCEZIBOX2	120 mm	85 mm	72 mm
ALCEZIBOX3	120 mm	120 mm	93 mm
ALCEZIBOX4	160 mm	120 mm	93 mm
ALCEZIBOX5	230 mm	120 mm	72 mm
ALCEZIBOX6	230 mm	175 mm	93 mm
ALCEZIBOX7	230 mm	175 mm	160 mm
ALCEZIBOX8	315 mm	244 mm	123 mm
ALCEZIBOX9	315 mm	244 mm	213 mm

## Nylon Cable Glands with Multi Hole Seals

- For indoor or outdoor Application
- Provides good seal on cable sheath
- Halogen Free
- UV resistant
- IP68 (50m) Approval
- Gland made of Polyamide
- Seal made of Neoprene
- Locknut is supplied as standard
- Temperature Range: -30°C to +80°C (up to 150°C intermittent)



Cat. No.	Cable Seal Hole Size	Thread Diameter x Length	Diameter Across Flats
ALCMG25-MHS2M5	2 x 5 mm	M25 x 15mm	29 mm
ALCMG25-MHS3M5	3 x 5 mm	M25 x 15mm	29 mm
ALCMG25-MHS4M5	4 x 5 mm	M25 x 15mm	29 mm
ALCMG25-MHS5M5	5 x 5 mm	M25 x 15mm	29 mm

Spare Seals			
Cat. No.	Cable Seal Hole Size	Description	Box Qty
ALCMHS25-2M5	2 x 5 mm	Multi-hole seal for ALCMG25 glands	50
ALCMHS25-3M5	3 x 5 mm	Multi-hole seal for ALCMG25 glands	50
ALCMHS25-4M5	4 x 5 mm	Multi-hole seal for ALCMG25 glands	50
ALCMHS25-5M5	5 x 5 mm	Multi-hole seal for ALCMG25 glands	50

## Ventilation Plugs

- Balances pressure differences between inner housing and the outside environment.
- Prevents damages according to pressure differences.
- Prevents the formation of water condensation in tightly sealed standard housings.
- Membrane properties: hydrophobic, oleophobic.
- Made from Polyimide 6



ALCVP-M12

## Nylon Blind Plug

- Nylon blind plug for junction boxes



ALCJBW-25P

## Hook Wrench

- Hook designed to match the Alco gland slot widths
- Hook designed for tightening C nuts & slotted Hex and OCT nuts
- One tool effectively tightens a range of cable glands with ease
- Hook wrench style make restricted access tightening easier
- Compact, cost effective and easy to use
- Complies to the standard AS4325.1



ALCHW80/125



ALCHW50/80

Cat. No.	Range Size	Length
ALCHW50/80	50mm - 80 mm	280 mm
ALCHW80/125	80mm - 125 mm	330 mm

## Earthing Rods

- Rigid mild steel central rod for easy insertion
- High conductivity copper casing gives excellent earth connectivity
- Tag and clip supplied with each rod
- Cost effective
- Readily available



ALCER1400

Cat. No.	Length	Diameter	Steel Core	Copper Thickness	Pack Qty
ALCER1400	1400mm	13mm	12.5mm	250 micron	10
ALCER1800	1800mm	13mm	12.5mm	250 micron	10

## Zinc Plated Metal Half Saddles

- For use indoors and outdoors
- Made from zinc plated mild steel



Cat. No.	Nominal Size	Securing Hole Diameter	Height	Length	Width	Pack Size
ALCS12H/100	12 mm	5 mm	11.5 mm	33.5 mm	16 mm	100
ALCS16H/100	16 mm	5 mm	15.5 mm	45 mm	19 mm	100
ALCS20H/100	20 mm	5 mm	20 mm	52 mm	19 mm	100
ALCS25H/100	25 mm	5.5 mm	24.5 mm	60 mm	25 mm	100
ALCS32H/50	32 mm	6.5 mm	31.5 mm	67 mm	25 mm	50
ALCS40H/50	40 mm	6.5 mm	40 mm	75 mm	32 mm	50
ALCS50H/25	50 mm	6.5 mm	49 mm	82 mm	39 mm	25

## Zinc Plated Metal Full Saddles

- For use indoors and outdoors
- Made from zinc plated mild steel



Cat. No.	Nominal Size	Securing Hole Diameter	Height	Length	Width	Pack Size
ALCS12F/100	12 mm	5 mm	12 mm	41.5 mm	13 mm	100
ALCS16F/100	16 mm	5 mm	16 mm	47 mm	13 mm	100
ALCS20F/100	20 mm	5 mm	20 mm	51 mm	16 mm	100
ALCS25F/100	25 mm	5.5 mm	25 mm	62 mm	19 mm	100
ALCS32F/50	32 mm	5.5 mm	32 mm	75 mm	25 mm	50
ALCS40F/50	40 mm	5.5 mm	40 mm	87 mm	25 mm	50
ALCS50F/25	50 mm	5.5 mm	50 mm	102 mm	25 mm	25

## Spring Girder Clips

- Zinc plated
- Spring steel
- Clamps on most common I-beam sizes
- Range suits all common conduits up to 32mm

Cat. No.	Description	Pack Size
ALCGC813	Spring girder clip, zinc coated steel 8-13mm	100
ALCS16F/100	Spring girder clip, zinc coated steel 16-20mm	100
ALCS20F/100	Spring girder clip, zinc coated steel 25-32mm	100

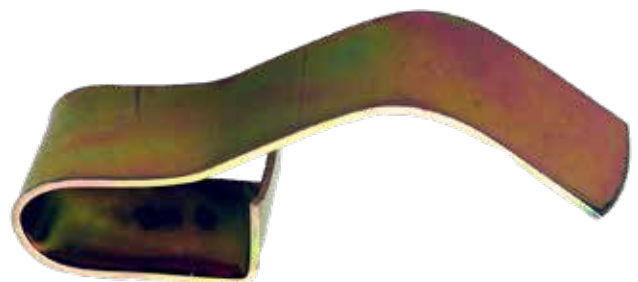

ALCGC813





Check out the different products in our new

## Clips & Fasteners Range

- Clips & Saddles
- Cavity Wall Anchors
- Concrete or Filled Block Anchors
- Needle Point Screws
- Drill Point Screws for Metal
- Drill Point Screws for Timber
- Metal Thread Screws

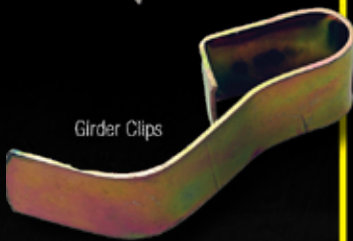



## NEW SIZES

### Non-insulated Bell Mouth Copper Lugs

- Non-insulated electro grade copper crimp lugs suitable for stranded to fine-stranded copper cable
- Electro tinned finish for high conductivity
- Includes inspection hole
- Conform to IS 191 (part V GR.ETP) specifications
- Operating temperature: -55°C to +155°C



ALCLBM35M12/25

Cat. No.	Conductor Size	Stud Size	Pack Qty
ALCLBM16M12/25	16 mm <sup>2</sup>	12 mm	25
ALCLBM120M16/10	120 mm <sup>2</sup>	16 mm	10
ALCLBM150M16/10	150 mm <sup>2</sup>	16 mm	10
ALCLBM300M10/3	300 mm <sup>2</sup>	10 mm	3
ALCLBM300M12/3	300 mm <sup>2</sup>	12 mm	3
ALCLBM400M10/3	400 mm <sup>2</sup>	10 mm	3
ALCLBM500M12/3	500 mm <sup>2</sup>	12 mm	3

### Non-insulated Bi-Metal Copper Lugs

- Termination of aluminium and aluminium alloy conductors to copper busbars and terminals
- Friction welded aluminium/copper crimp lugs
- Suitable for use with standard 6 ton and 12 ton Australian hex crimp dies
- Printed with crimp indicator marks
- Pre-drilled copper palms
- Pre-greased aluminium barrels to reduce corrosion
- Hi purity aluminium 99.6%
- ETP Copper 99.9%
- All sizes can be sold individually



ALCLCA120M12

Cat. No.	Conductor Size	Stud Size	Pack Qty
ALCLCA70M10	70 mm <sup>2</sup>	10.5 mm	10
ALCLCA95M10	95 mm <sup>2</sup>	10.5 mm	10
ALCLCA120M10	120 mm <sup>2</sup>	10.5 mm	10
ALCLCA150M10	150 mm <sup>2</sup>	10.5 mm	10
ALCLCA185M10	185 mm <sup>2</sup>	10.5 mm	6
ALCLCA300M10	300 mm <sup>2</sup>	10.5 mm	6
ALCLCA400M10	400 mm <sup>2</sup>	10.5 mm	3

### Non-insulated Long Palm, Long Barrel Copper Lugs

- Non-insulated electro grade copper crimp lugs suitable for stranded to fine-stranded copper cable
- Made with a long barrel and a long palm
- No hole
- Electro tinned finish for corrosion resistance
- 99.9% copper for high conductivity
- Operating temperature: -55°C to +155°C
- All sizes sold individually



ALCLLPB240

Cat. No.	Conductor Size	Barrel Length	Tongue Length
ALCLLPB25	25 mm <sup>2</sup>	61 mm	94 mm
ALCLLPB70	70 mm <sup>2</sup>	100 mm	154 mm
ALCLLPB120	120 mm <sup>2</sup>	100 mm	168 mm
ALCLLPB150	150 mm <sup>2</sup>	100 mm	169 mm
ALCLLPB185	185 mm <sup>2</sup>	100 mm	174 mm
ALCLLPB240	240 mm <sup>2</sup>	100 mm	192 mm

## Non-insulated Long Barrel Copper Lugs

- Non-insulated electro grade copper crimp lugs suitable for stranded to fine-stranded copper cable
- Electro tinned finish for corrosion resistance
- 99.9% copper for high conductivity
- Operating temperature: -55°C to +155°C
- All sizes can be sold individually



Cat. No.	Conductor Size	Stud Size	Barrel Length
ALCLLB10M6	10 mm <sup>2</sup>	6.5 mm	18 mm
ALCLLB25M10	25 mm <sup>2</sup>	10.5 mm	29 mm
ALCLLB35M8	35 mm <sup>2</sup>	8.4 mm	35 mm
ALCLLB35M12	35 mm <sup>2</sup>	13 mm	35 mm
ALCLLB120M12	120 mm <sup>2</sup>	13 mm	60 mm
ALCLLB185M12	185 mm <sup>2</sup>	13 mm	64 mm
ALCLLB240M12	240 mm <sup>2</sup>	13 mm	80 mm

## Non-insulated Circuit Breaker Copper Lugs

- Non-insulated electro grade copper crimp lugs suitable for stranded to fine-stranded copper cable
- Electro tinned finish for corrosion resistance
- 99.9% copper for high conductivity
- Includes inspection port
- Operating temperature: -55°C to +155°C
- All sizes can be sold individually



Cat. No.	Conductor Size	Stud Size	Palm Width
ALCLCB50M6	50 mm <sup>2</sup>	6.2 mm	15 mm
ALCLCB50M10	50 mm <sup>2</sup>	10.2 mm	19 mm
ALCLCB150M10	150 mm <sup>2</sup>	10.2 mm	19 mm
ALCLCB240M12	240 mm <sup>2</sup>	13 mm	31 mm
ALCLCB300M10	300 mm <sup>2</sup>	10.5 mm	31 mm

## Non-Insulated Copper Reducing Links

- Uninsulated electrolytic grade copper crimp links for stranded and fine stranded copper conductors (class 2,5 and 6).
- Electro-tin plated for corrosion resistance.
- Chamfered ends for ease of entry of stranded conductors.
- Suitable for use with standard 6 tonne, 12 tonne and indent and hex crimp tools.
- All sizes sold individually
- Compliance with Standard AS 4325.1
- Operating temperature: -55°C to + 150°C



Cat. No.	Large Barrel ID	Small Barrel ID	Overall Length
ALCLKR25-6	7.5 mm	4.0 mm	40 mm
ALCLKR50-16	9.5 mm	5.5 mm	55 mm
ALCLKR70-16	11.5 mm	5.5 mm	60 mm
ALCLKR70-25	11.5 mm	7.5 mm	60 mm
ALCLKR95-25	13.5 mm	7.5 mm	65 mm
ALCLKR95-35	13.5 mm	8.5 mm	65 mm
ALCLKR120-35	15.5 mm	8.5 mm	70 mm
ALCLKR120-50	15.5 mm	8.5 mm	70 mm
ALCLKR120-70	15.5 mm	9.5 mm	75 mm
ALCLKR120-95	15.5 mm	13.5 mm	75 mm
ALCLKR150-95	16.5 mm	13.5 mm	80 mm
ALCLKR150-120	16.5 mm	15.5 mm	80 mm
ALCLKR185-70	18.5 mm	11.5 mm	75 mm
ALCLKR185-95	18.5 mm	13.5 mm	80 mm
ALCLKR185-120	18.5 mm	15.5 mm	85 mm
ALCLKR185-150	18.5 mm	16.5 mm	85 mm
ALCLKR240-95	21.5 mm	13.5 mm	85 mm
ALCLKR240-185	21.5 mm	18.5 mm	95 mm

## 6 Ton Die Kit

- 6 Ton Copper Die Kit
- 12 pieces stored in convenient case
- For hexagonal crimping of cable
- Dies can also be sold individually



ALCK6-DIEKIT

Cat. No.	Kit Contains
ALCK6-DIEKIT	ALCK6-C10 6 ton copper die for 10mm <sup>2</sup> cable
	ALCK6-C16 6 ton copper die for 16mm <sup>2</sup> cable
	ALCK6-C25 6 ton copper die for 25mm <sup>2</sup> cable
	ALCK6-C35 6 ton copper die for 35mm <sup>2</sup> cable
	ALCK6-C50 6 ton copper die for 50mm <sup>2</sup> cable
	ALCK6-C70 6 ton copper die for 70mm <sup>2</sup> cable
	ALCK6-C95 6 ton copper die for 95mm <sup>2</sup> cable
	ALCK6-C120 6 ton copper die for 120mm <sup>2</sup> cable
	ALCK6-C150 6 ton copper die for 150mm <sup>2</sup> cable
	ALCK6-C185 6 ton copper die for 185mm <sup>2</sup> cable
	ALCK6-C240 6 ton copper die for 240mm <sup>2</sup> cable
	ALCK6-C300 6 ton copper die for 300mm <sup>2</sup> cable

## 12 Ton Die Kit

- 12 Ton Copper Die Kit
- 12 pieces stored in convenient case
- For hexagonal crimping of cable
- Dies can also be sold individually



ALCK12-DIEKIT

Cat. No.	Kit Contains
ALCK12-DIEKIT	ALCK12-C16 12 ton copper die for 16mm <sup>2</sup> cable
	ALCK12-C25 12 ton copper die for 25mm <sup>2</sup> cable
	ALCK12-C35 12 ton copper die for 35mm <sup>2</sup> cable
	ALCK12-C50 12 ton copper die for 50mm <sup>2</sup> cable
	ALCK12-C70 12 ton copper die for 70mm <sup>2</sup> cable
	ALCK12-C95 12 ton copper die for 95mm <sup>2</sup> cable
	ALCK12-C120 12 ton copper die for 120mm <sup>2</sup> cable
	ALCK12-C150 12 ton copper die for 150mm <sup>2</sup> cable
	ALCK12-C185 12 ton copper die for 185mm <sup>2</sup> cable
	ALCK12-C240 12 ton copper die for 240mm <sup>2</sup> cable
	ALCK12-C240 12 ton copper die for 300mm <sup>2</sup> cable
	ALCK12-C400 12 ton copper die for 400mm <sup>2</sup> cable

# Wattmaster

## 6 Ton 18V Battery Crimper with Dies

- Suitable for crimping in narrow working spaces
- Built in safety valve, automatic pressure-relief at Max.pressure.
- Super quick, light weight and easy to operate.
- High power capacity, high performance 18V li-ion battery with quick charger.
- Crimping Force: 60kN
- Rated Pressure: 700 bar
- Crimping Capacity: Cu 6-240mm<sup>2</sup>, AL 16-240mm<sup>2</sup>
- Weight of Complete Kit: 9.46 kg
- Weight of Crimper & Battery: 3 kg

Cat. No.	Kit Contains
WATBCT-6022M/WD	WATBCT-6022M 6 ton 18V crimping tool with 2 x batteries, charger and instruction manual.
	ALCK6-C10 6 ton copper die for 10mm <sup>2</sup> cable
	ALCK6-C16 6 ton copper die for 16mm <sup>2</sup> cable
	ALCK6-C25 6 ton copper die for 25mm <sup>2</sup> cable
	ALCK6-C35 6 ton copper die for 35mm <sup>2</sup> cable
	ALCK6-C50 6 ton copper die for 50mm <sup>2</sup> cable
	ALCK6-C70 6 ton copper die for 70mm <sup>2</sup> cable
	ALCK6-C95 6 ton copper die for 95mm <sup>2</sup> cable
	ALCK6-C120 6 ton copper die for 120mm <sup>2</sup> cable
	ALCK6-C150 6 ton copper die for 150mm <sup>2</sup> cable
	ALCK6-C185 6 ton copper die for 185mm <sup>2</sup> cable
	ALCK6-C240 6 ton copper die for 240mm <sup>2</sup> cable



### Spare Parts

Cat. No.	Description
WATBCT-SB	Multi-hole seal for ALCMG25 glands

## Hand Crimper with Detachable Handles

- Hand operated mechanical crimping tool for copper lugs and links.
- Built-in crimp die set for all standard conductor sizes from 6 to 120mm<sup>2</sup>.
- Dies lock into place for consistent crimping.
- No dies to replace; simply rotate and unlock die to required crimp size
- Comes with detachable click in handles in a handy carry case the keeps pieces together and prolongs tool life.
- Crimp Type: Hexagonal
- Crimping Capacity: 6.0 – 120.0mm<sup>2</sup> Lugs & Links
- Crimp Length: 5 mm
- Length: 660 mm
- Weight: 3.5 kg



## Solar Connector Crimping Tool

- Crimper for multi-contact MC4 solar PV core connector
- Ergonomically designed handles
- Made from drop forged carbon steel
- Lightweight and easy to operate
- Ratchet controlled for consistent results
- Crimping Capacity pre-insulated terminals: MC4 2.5, 4 & 6mm<sup>2</sup> solar connectors
- Length: 230mm
- Weight: 480 g



## Guided Solar Connector Crimping Tool

- Crimper for multi-contact MC4 solar PV core connector
- With regulating and locating housing
- Ergonomically designed handles
- Made from drop forged carbon steel
- Lightweight and easy to operate
- Ratchet controlled for consistent results
- Crimping Capacity: MC4 2.5, 4 & 6mm<sup>2</sup> solar connectors
- Length: 200mm
- Weight: 380 g



## Cable Cutting Pliers

- Heavy duty
- Diamond pattern nose grip
- Chain grip
- Precise tip clearance
- Extra-long cutter blades
- Made from drop forged hardened steel
- Cutting Capacity copper wire: 0-25mm<sup>2</sup>
- Cutting Capacity 3C flat cable: 0-2.6mm<sup>2</sup>
- Crimping Capacity non-insulated terminals: 1.25 – 2.0mm<sup>2</sup>
- Length: 215mm
- Weight: 340g



WATMVA200R

## High Leverage Cutting Nippers

- High Leverage
- Drop forged
- Heavy Duty non slip comfort handle grips
- Heavy duty beveled blades
- Cuts steel and copper wire
- Cutting Capacity copper wire: 0-3.0mm<sup>2</sup>
- Cutting Capacity 3C flat cable: 0-2.0mm<sup>2</sup>
- Cutting Capacity steel wire: 0-2.6mm<sup>2</sup>
- Length: 200mm
- Weight: 340g



WATMA730R

## Flush Cutting Nippers

- Flush cutting nippers for soft wire
- Black finish with polished jaws
- Fully heat treated with dipped vinyl handle grips
- Made from drop forged chrome vanadium steel
- Ground head
- Cutting Capacity copper wire: 0-2.6mm<sup>2</sup>
- Cutting Capacity steel wire: 0-1.6mm<sup>2</sup>
- Length: 150mm
- Weight: 120g



WATMA600B



## Backpack Aprentice Kit

- 9 piece Aprentice backpack kit
- Stored in backpack with 39 pockets for tons of tool storage and a Fully molded bottom to protect from the elements
- Items also available individually

Kit Contains		
Cat. No.	Description	Qty
A-55421BP-14	Klein Backpack	1
A-MM300	Klein Digital Multi Meter	1
A-NCVT-1	Klein Non-contact Voltage Tester	1
A-3005CR	Klein Ratchet Crimper	1
WATMVA200R	Wattmaster Cable Cutters	1
WATMA730R	Wattmaster Side Cutters	1
WATMA600B	Wattmaster Nippers	1
A-32690-INS	Klein 4 Piece Insulated Screwdriver Set	1
A-31737	Klein Folding Jab Saw	1



WATWK-KIT1

## Tote Bag Aprentice Kit 2

- 9 piece Aprentice tote bag kit
- Stored in tote bag with a large zipper pocket to secure small parts and tools, 40 pockets for maximum tool storage and a fully molded bottom to protect from the elements
- Items also available individually

Kit Contains		
Cat. No.	Description	Qty
A-5541610-14	Klein 10 Inch Tote Bag	1
A-CL110	Klein Digital Clamp Meter	1
A-NCVT-1	Klein Non-contact Voltage Tester	1
A-3005CR	Klein Ratchet Crimper	1
WATMA880W	Wattmaster Linesman Pliers	1
WATMA730R	Wattmaster Side Cutters	1
WATMA600B	Wattmaster Nippers	1
A-32690-INS	Klein 4 Piece Insulated Screwdriver Set	1
A-31737	Klein Folding Jab Saw	1



WATWK-KIT2

## 10M Glow Rod Kit

- Ideal for gaining access to cables in areas where there is limited access e.g. floorboards, ceiling cavities etc.
- Rods can be easily threaded together
- Glow-in-the-dark and lightweight
- Recharge by exposing to an ultra violet source e.g. sunlight or fluorescent light
- Tensile strength on connectors is >2000N (200kg force)
- Sold as kit only

Cat. No.	Kit Contains
SRS-GR10	10 x GRP Rods 4mm x 1m
	1 x Mini Eye
	1 x Mini Hook
	1 x Flexi Lead



SRS-GR10

## Fasty Straps

- UV-resistant high tenacity polypropylene straps
- Buckles are made of steel.
- Buckles have environmentally friendly anti-corrosive coatings.
- Buckles designed in-house
- Complies to Australian New Zealand Standards AS/NZ4380:2001
- Display bucket contains 12pc of the listed individual straps

Cat. No.	Description	Strength
WATFS-127	Transport strap display bucket with 60 Straps	400 kg
WATFS-121	White transport strap 1m x 25mm	400 kg
WATFS-122	Yellow transport strap 1.5m x 25mm	400 kg
WATFS-123	Blue transport strap 2m x 25mm	400 kg
WATFS-124	Red transport strap 2.5m x 25mm	400 kg
WATFS-125	Black transport strap 3.5m x 25mm	400 kg



WATFS-127



Buckle



AS/NZ4380:2001 Standards Tag



WATFS-121



WATFS-122



WATFS-123



WATFS-124



WATFS-125

## Hand Sanitiser

- Antibacterial hand sanitiser
- Kills germs without use of water
- 500mL Pump Bottle
- 75% Ethanol

Disclaimer: Not recommended for use in hospital grade environments.



WATHANDSAN-DL

## Hand Sanitiser

- Antibacterial hand sanitiser
- Kills germs without use of water
- 500mL Pump Bottle
- 70% Ethanol

Disclaimer: Not recommended for use in hospital grade environments.



WATHANDSAN

## Sanitising Wipes

- Antibacterial sanitising wipes
- Kills 99.9% of germs
- 75% Alcohol
- 15cm x 20cm large wipes
- 50 pack



WATSANWIPES

## Sanitiser Pack

Kit Contains		
Cat. No.	Description	Qty
WATFW-S101	Hospital Grade Disinfectant Anti-Bacterial Wipes 70% Alcohol	1
WATHANDSAN-DL	500ml Hand Sanitiser Gel With Aloe Vera	1
WATSANWIPES	Anti-Bacterial Sanitising Wipes 75% Alcohol 50 wipes in a pack	1
A-60439	Klein Cooling Neck Band	1



WATSANITISEPACK

# KLEIN TOOLS®



## A U S T R A L I A

**Home to all the brands you know and trust**

# KLEIN TOOLS®



 Klein Tools Australia

 @klein\_tools\_au

# Wattmaster

 Wattmaster

 @wattmaster\_au

# MUMME TOOLS

 Mumme Tools

 @mumme\_tools

# Alco

 Alco

 @alco\_cableglans



**52 WEEKS OF**

**Alco**  
Used by sparkys everyday

# **ELECTRIC** **INFLUENCER**



***SCAN THE BARCODE  
TO WATCH THE  
LATEST EPISODE.***

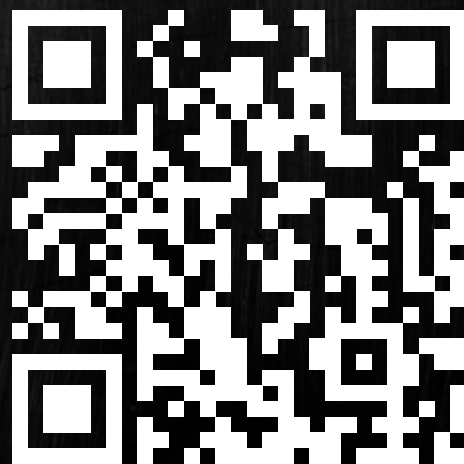



# TRADES CLUB

## Join the Trades Club

at [www.kleintools.com.au](http://www.kleintools.com.au) for new products,  
innovations and chances to win FREE tools!

- ELECTRICAL
- DATA COM
- HVAC
- TELECOM
- UTILITY
- PLUMBING
- HEAVY INDUSTRY
- STEEL & CONCRETE CONSTRUCTION

**KLEIN**  
**TOOLS**  
AUSTRALIA



See our complete range of products at  
[www.kleintools.com.au](http://www.kleintools.com.au)

